

# FALKLAND

suspension

Bruno Munari | 1964

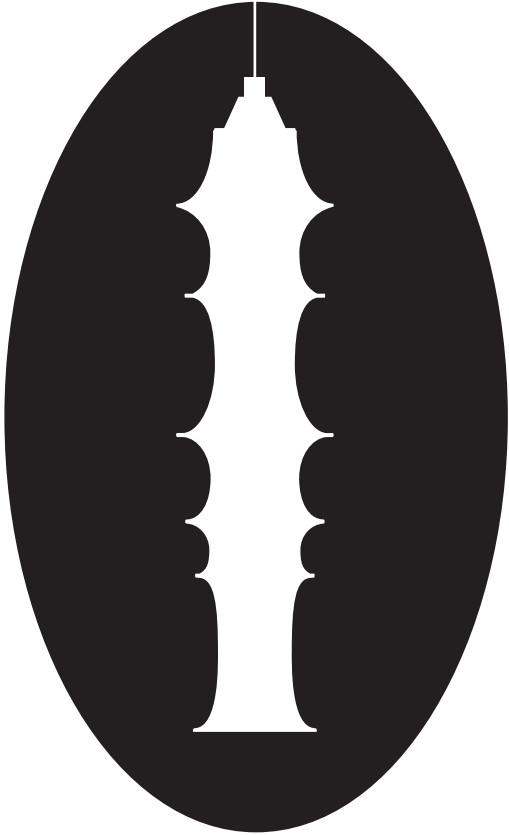

---

165 / 85 / 53

MADE IN ITALY



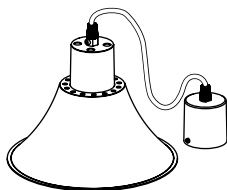
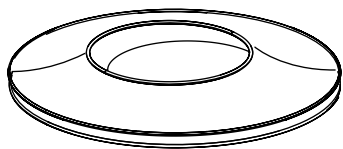
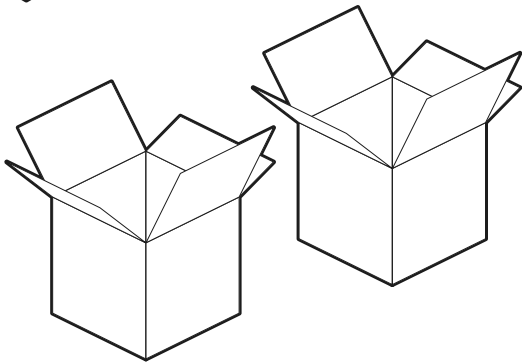
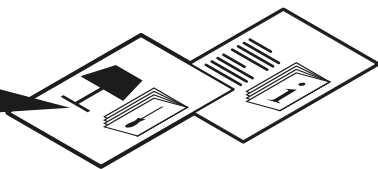
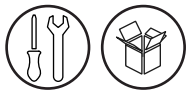
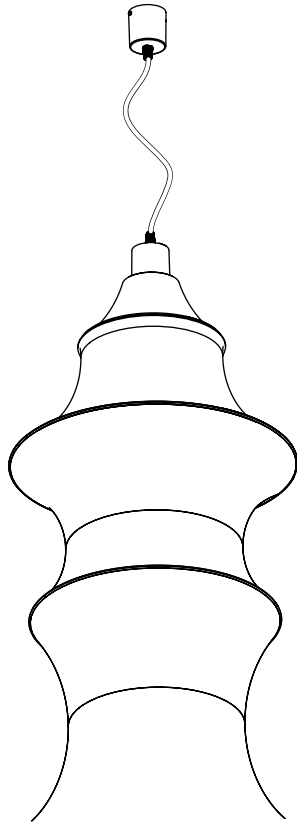
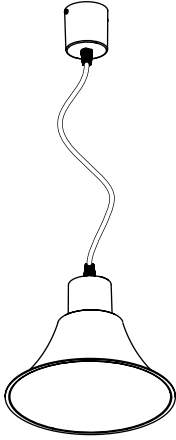
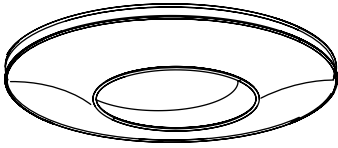

Fig. 1



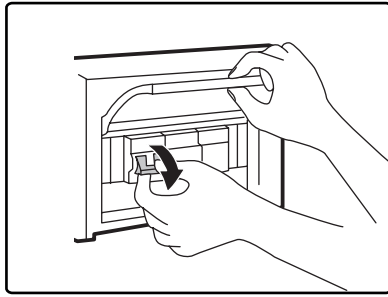

Fig. 2

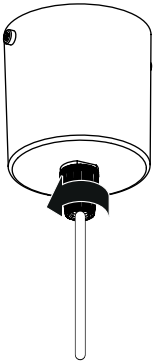

Fig. 3

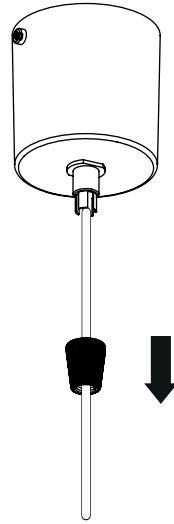

Fig. 4

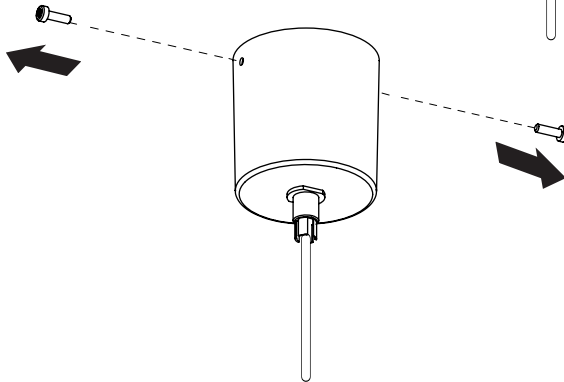

Fig. 5

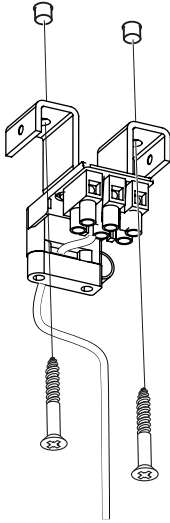

Fig. 6

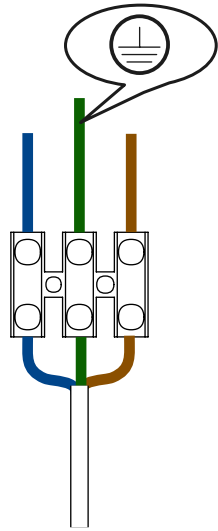

Fig. 7

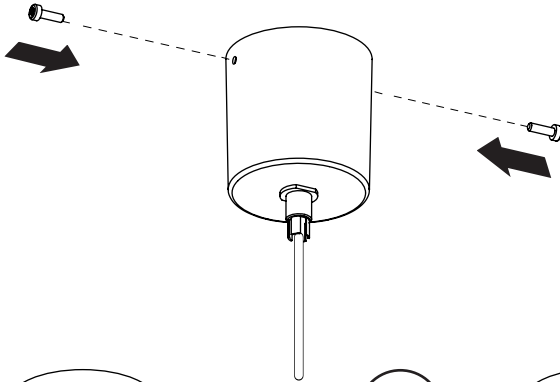

Fig. 8

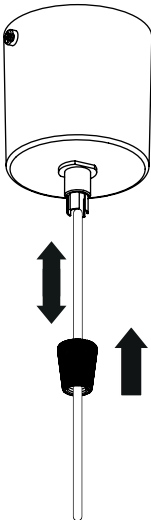

Fig. 9

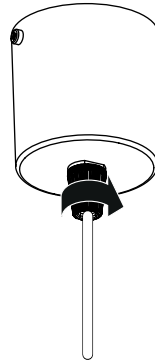
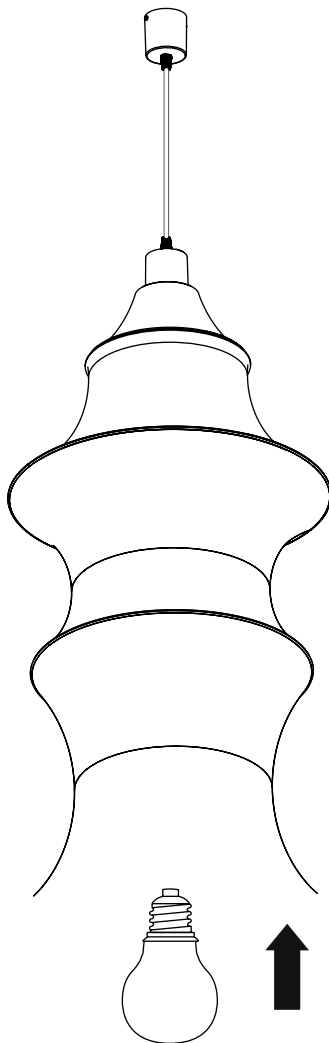

Fig.9



<b>220 - 240 V / 50 - 60 Hz</b>	
<b>MAX 77W (E27)</b>	
Halo: HSGSA	1300 lm
LED: DRAA	1000 lm



**Falkland**

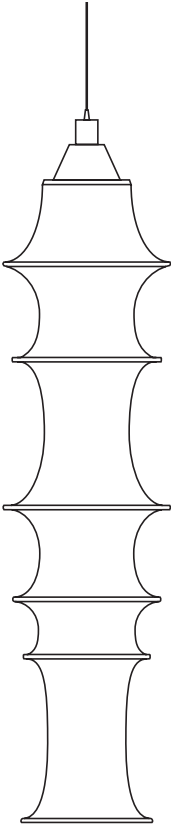

**Falkland 85**

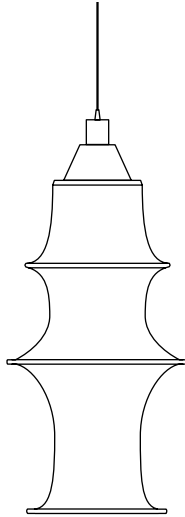

**Falkland 53**

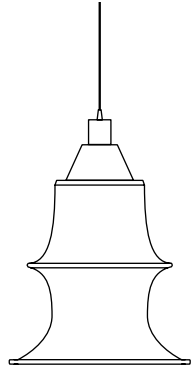

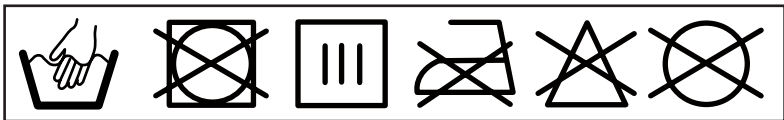
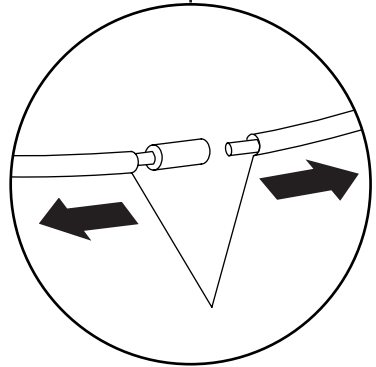
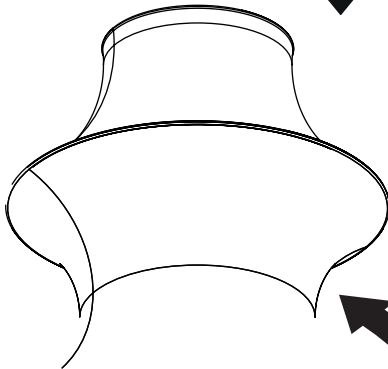
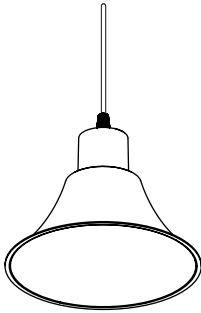
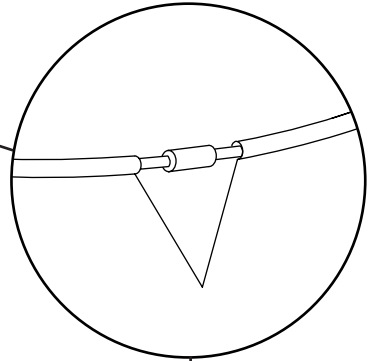
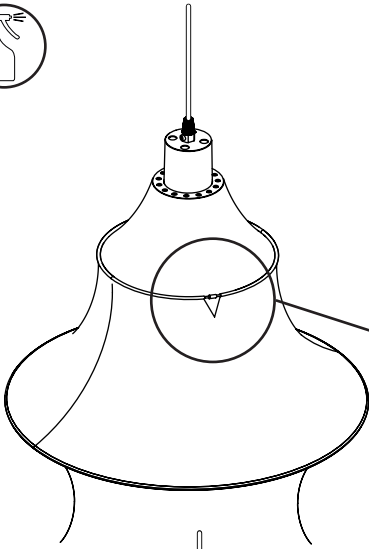









## DANESE

---

VIA ANTONIO CANOVA 34

---

20145 MILANO

---

T. +39.02.349611

F. +39.02.34538211

info@danese milano.com

www.danese milano.com

## SHOWROOM

---

PIAZZA SAN NAZARO IN BROLO 15

---

20122 MILANO

---

T. +39.02.58304150

F. +39.02.58433350

showroomdanese@artemide.com

# DANESE



# MILANO | Artemide®

VIA BERGAMO 18

---

20010 PREGNANA MILANESE (MI) ITALY

---

T. +39.02.935181 - 935261

Numero Verde 800 834 093 (from Italy only)

© JULY 2016 DANESE

---

DANESE reserves the right to change, at any time and without prior warning, the technical specification of any product illustrated in this instruction.

cod. Y513000624